



## INSTALLATION, COMMISSIONING, PROGRAMMING & USER INFORMATION

# PRISMERTEC WATER SOFTENER

These instructions are designed to give you the customer a complete understanding of how to locate, install, programme and obtain trouble-free running of your AQUA-DIAL PRISMERTEC WATER SOFTENER.

Whether you intend to install the unit yourself or obtain the services of a tradesman, please spend a few minutes reading through this booklet and the other enclosed details. It will give you a complete understanding of the "SOFT WATER WORLD" that you are about to enter. **PLEASE RETAIN FOR FUTURE REFERENCE.**

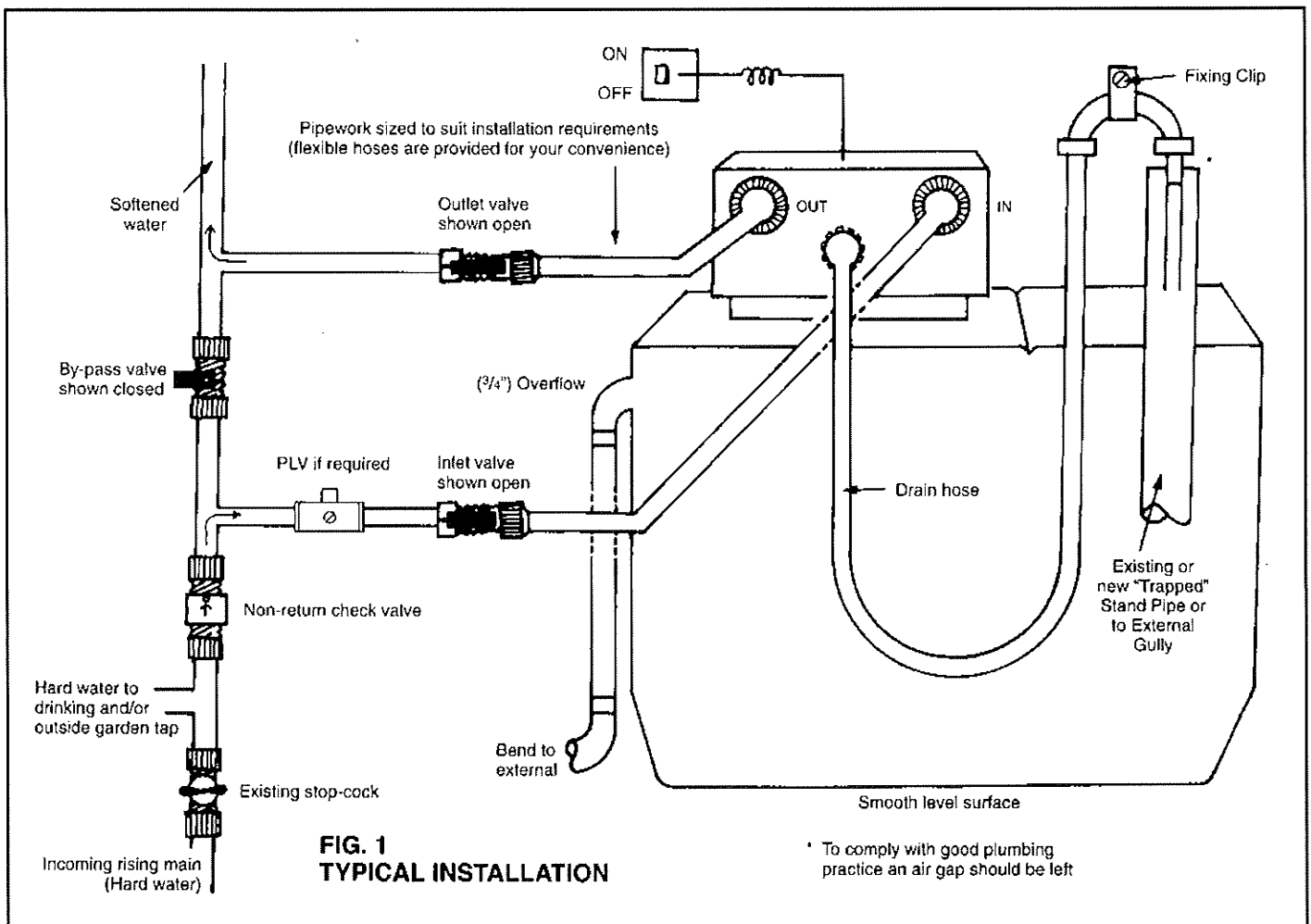

### LOCATION

The softener should be located as close as practicable to the incoming cold rising main supply. Very often (*but not always*) this main is in the kitchen or utility room. Sometimes the main rises in a downstairs cloakroom, under the stairs, or in the garage. In most cases the softener can be sited in any of these locations as well as outside (*with suitable frost protection*) or even in the loft space (when sited in a loft, a safety tank is advisable).

### REQUIREMENTS

**THE SOFTENER REQUIRES**  
Mains Water Supply 20-60 p.s.i.  
(1.36-4.0 Bar) pressure.  
A waste connection.  
An electrical point.  
Access for salt filling and service.

# PRE-INSTALLATION

## INSTALLATION

Your Softener comes complete with a basic 12mm flexible trade installation kit (*see detail sheet with kit*). Alternatively you can disregard the hoses and "hard plumb" the connections in 15mm or 22mm copper tube.

**Unvented plumbing and hot water Systems:** Disregard the inlet and outlet hoses, valves and non-return check valve. "Hard plumb" using 22mm copper tube and fittings. A 22mm (3/4") non-return check valve will also be required. It must be UK W.F.B.S. listed.

### PRESSURE LIMITING VALVE (P.L.V.)

Your Prismertec will only operate at optimum performance between 1.4 Bar (20 p.s.i.) and 4 Bar (60 p.s.i.).

It is essential that a P.L.V. is fitted where water pressure in excess of 4 Bar is found.

For unvented or maximum flow rate requirements this Softener should be hard plumbed using 22mm copper tube, valves and fittings as shown in Fig. 2.

**Note: Water pressure will typically increase overnight or during periods of low demand. The Prismertec regenerates at night and this should be considered when establishing the necessity for pressure control.**

The following are available from Aqua-Dial or your supplier:

1. 22mm (3/4") non-return valve.
2. Pressure reducing valve for high pressure areas.
3. Hardness test kit: For accurate testing.
4. Drinking water tap: For hard water drinking point.
5. Drinking water filter kits.
6. 5m low voltage extension lead (specify Prismertec).

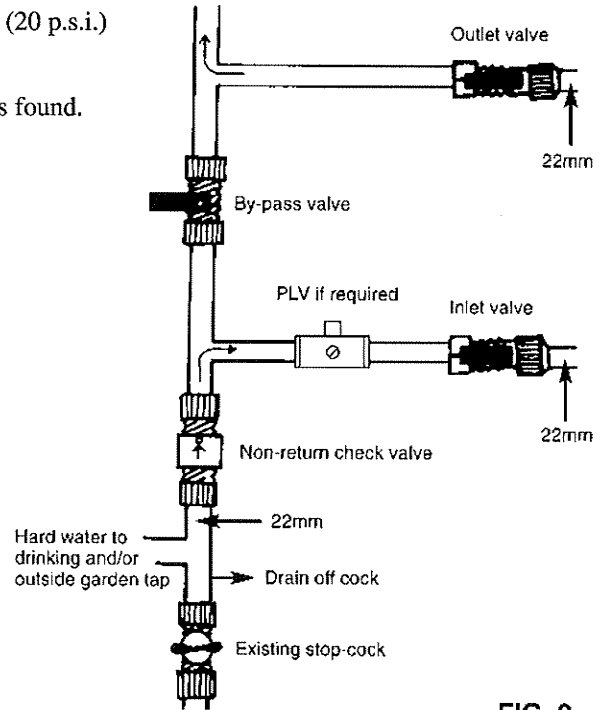

FIG. 2

**NOTE - If an outside tap is installed a "double check valve" must be fitted to the outside tap.**

## CHOOSING THE BEST POSITION

By using the Prismertec's unique indexing system you can select the easiest valve position to suit your requirements.

FIG. 3

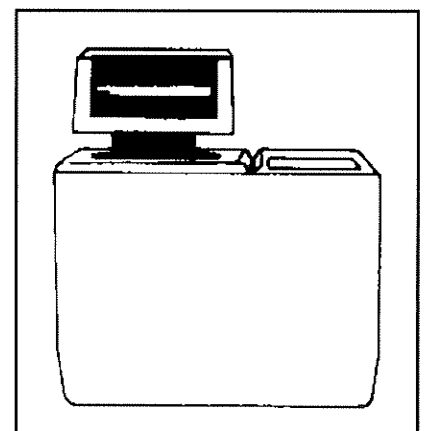
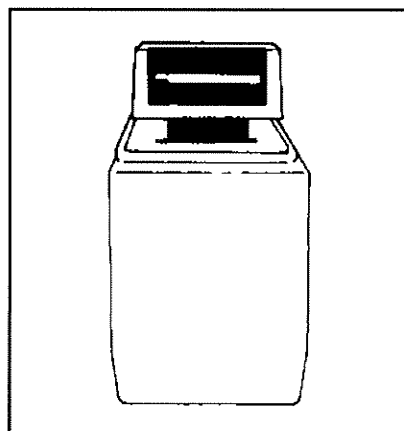
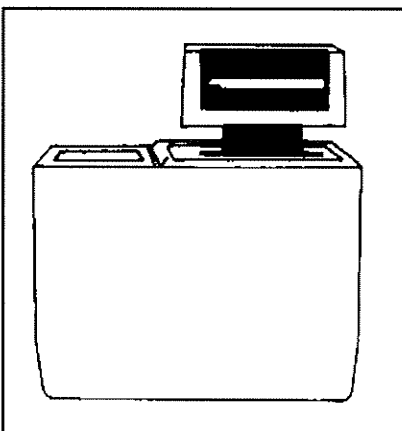

## TO ALTER THE VALVE POSITION - ALL MODELS

1. Unscrew the four plastic screws and keep safely (Fig. 4).
2. Release the nut and clip from the brine pick-up tube (Fig. 5).
3. Carefully lift the entire valve head pressure vessel and brine pick-up tube. Replace to new position (Fig. 6).
4. Re-route the brine pick-up tube and refix the bracket and nut (Fig. 7).
5. Replace the four plastic screws loosely on the top plate - tighten when all four are located.

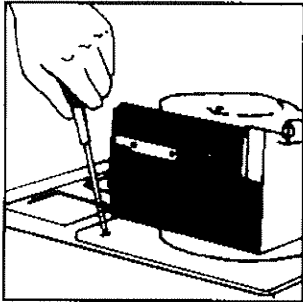

FIG. 4

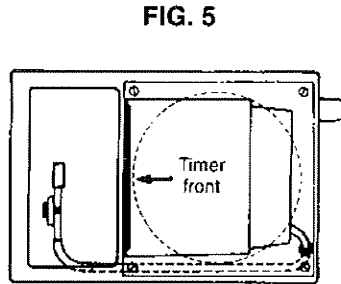

FIG. 5

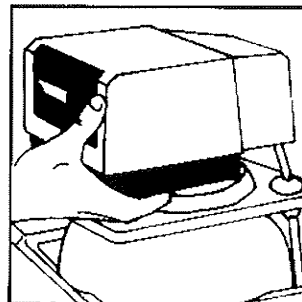

FIG. 6

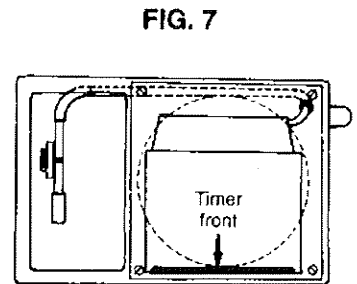

FIG. 7

If at any time you need to remove the brine tube from the push-fit couplings, simply push in the collet and pull out the tube (Fig. 8).

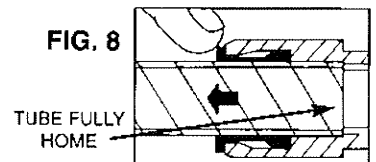

FIG. 8

**NOTE - Do not shorten or cut brine pick-up tube.**

### LOW-HEIGHT - RESTRICTIONS (under low sinks etc)

If you are in a situation where height is a problem, it is possible to mark out the shape of the Softener cabinet and cut out the wooden plinth. Allow the "Cut-Out" to fall through the hole to act as a smooth base for the Softener to sit on. The gap between the Softener and the cut out can be filled with a plastic edging strip.

It is also possible to cut off the back section of the valve cover to allow the cover to pull forward rather than have to be lifted up.

## INSTALLATION

### 1 STARTING THE INSTALLATION

Before commencing the installation, ascertain that the water pressure is not too low or high. Optimum operating pressure is 1.4 to 4 Bar (20 to 60 p.s.i.). If daytime pressure exceeds 4 Bar (60 p.s.i.), then a pressure limiting valve should be installed. These are available from your supplier and should be located as shown in Fig. 1. Pressure can be determined by applying a gauge to an outside tap or single pillar tap or by contacting your local Water Board. If water splashes out over the sink when the cold tap is turned fully on, it is a good indication of high pressure.

**NOTE - Water pressure must never be allowed to exceed 4 Bar (60 p.s.i.).**

### 2 DRAIN THE RISING MAIN

Turn off the existing cold mains supply stopcock and drain down any water in the pipe via the "drain off cock" or kitchen cold tap. To allow air to enter the main via the ballvalve in the loft tank, run a small amount of water from the cold tap in the bathroom. If all your cold supply connections are off the rising main, open a tap at the highest point.

### 3 INSTALLING THE BY-PASS SET

Cut the rising main and install the inlet, outlet and by-pass valves as shown in Fig. 1. Install the non return check valve and connect hard water supply to kitchen drinking tap and/or outside garden supply (if required). Re-site or install a "drain off cock" as indicated. Fit the pressure limiting valve (if applicable) prior to the hard water inlet to the softener.

Turn the inlet and outlet valves to closed (handle pointing across water flow). Turn the by-pass valve to open (handle pointing with the water flow).

Ensure the "drain off cock" is closed and turn back on the existing stopcock. This will allow hard water to again enter the system.

#### 4 CONNECTING INLET/OUTLET HOSES

From the inlet valve connect a hose to the "PORT" marked hard water inlet → on the softener control valve (Fig. 1). Ensure that the rubber washers (Fig. 9) are in place and hand tighten nut plus half turn with spanner. Connect outlet hose from outlet valve to softener in the same manner.

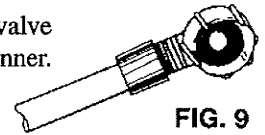
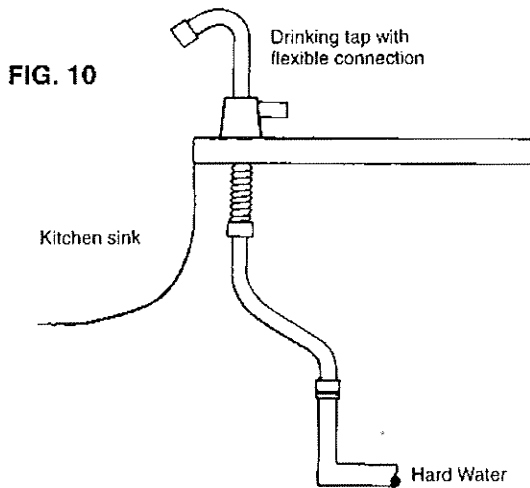

FIG. 9

#### 5 CONNECTING THE HARD WATER DRINKING TAP

The cold supply to the kitchen sink can be left on hard water or alternatively a separate hard water tap can be installed as Fig. 10. Aqua-Dial can supply a hard water drinking tap kit.



#### NOTE - IMPORTANT!

Softening water increases the sodium content of raw water. Anybody on a sodium free or low sodium diet should not drink softened water. Do not use softened water in artificial baby feeds. Where practicable install a separate hard water drinking tap.

The Aqua-Dial Drinking Water Filter Kit.



FIG. 11

A complete kit to give you clear fresh tasting drinking water. Available from your Aqua-Dial supplier.

#### 6 PLUMBING THE DRAIN CONNECTION

The drain outlet for the softener is located between the inlet and outlet port. See Fig. 1. The drain operates under mains pressure during regeneration. White flexible drain hose is supplied with a pre-jointed elbow. The drain hose may be run into an existing or new "stand-pipe" (as in a washing machine installation) or directly into an external gully. If the drain hose is exposed to the outside, the part outside should be insulated to prevent freezing.

The drain can be connected to a soil stack via a deep-seal trapped connection and "stand-pipe". As the drain is under pressure, it may be elevated as in cellar or under stair type installations.

Always leave an air gap between water level and hose outlet when discharging into a stand-pipe. Secure the hose at stand pipe to prevent "kinking" and accidental removal or "blow out" of the hose. Using the plastic 'U' bracket and the pipe clip supplied in the kit.

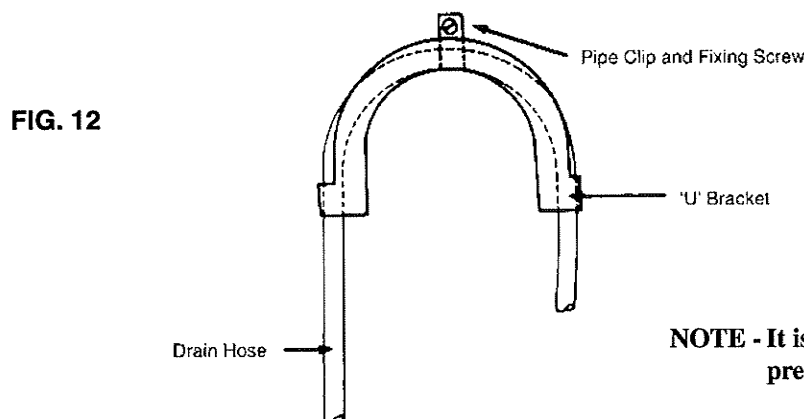

NOTE - It is important that the pipe clip is used to prevent the hose slipping out.

#### 7 OVERFLOW CONNECTION

The overflow connection is located at the rear of the softener. It is not under pressure and cannot be elevated. The overflow pipe must run downhill and terminate outside the building. Use 22mm rigid plastic overflow pipe in conjunction with the elbow supplied. See Fig. 1. Always try to have a vertical drop as shown.

The 22mm rigid plastic overflow pipe can be obtained from your supplier. It is also suitable for long runs.

The overflow bend supplied on the Softener can be adapted to "OSMA" or similar "solvent weld" system by purchasing a suitable adaptor.

## 8 ELECTRICAL CONNECTION

The softener must be connected to an electrical supply. The consumption is only three watts which is used to drive the power unit. All other cycles on the valve are operated by water pressure. The Prismertec has low voltage for safety and is supplied with a plug in transformer. Connect the transformer to a 13 amp socket. The supply must be continuous. A 5 metre extension lead is available from Aqua-Dial or your supplier. Please specify Prismertec. The transformer lead should be plugged into the processor socket (this is found at the bottom left of the display panel).

## POWER FAILURES

In the event of an electrical power failure, all operational information will be retained in a Nonvolatile Random Access Memory, NOVRAM. During the failure, the controller will not keep time or measure water flow. When power is restored, all functions will continue on from the time of the failure.

**NOTE - A battery back-up feature is available to maintain the correct time of day. This will require a 9 volt alkaline battery which should be connected to the terminal provided on the back of the processor.**

## 9 COMMISSIONING

### IMPORTANT!

**Ensure that the water and electrical supplies are switched OFF BEFORE attempting to commission your water softener.**

1. Remove the control valve cover by grasping each side of the cover at the bottom, towards the back. Spread the sides apart slightly and lift off.
2. Locate the black button (Fig. 14) and press down to disengage the cam gear.
3. With the cam gear disengaged, rotate the cam gear anti-clockwise so that the indicator arrow points to the "W" in the word BACKWASH (Fig. 15).
4. Open the inlet valve (Fig. 1) partially to allow the resin vessel to fill. Water will run to drain when the resin vessel has filled. At this point fully open the inlet valve and allow water to run for five minutes.
5. Disengage the cam gear and slowly advance it to "service".
6. Switch on the power supply. The cam gear should automatically travel to its rest position (approximately in the centre of "service") at which point the drive motor will switch off.
7. Close the by-pass valve and open the outlet valve (Fig. 1).
8. Remove the salt lid and pour in 2.5 litres (5 pints) of water.
9. Add salt 10-20kg.

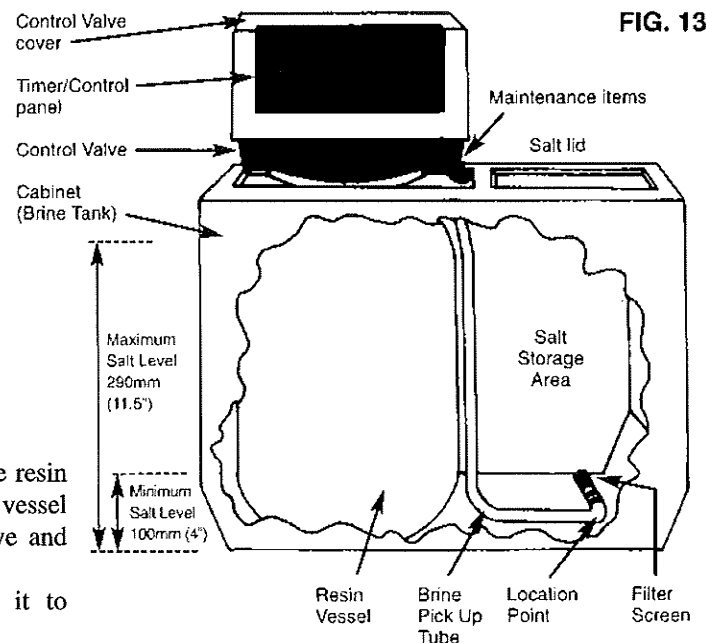

**PRISMERTEC MAIN COMPONENTS**

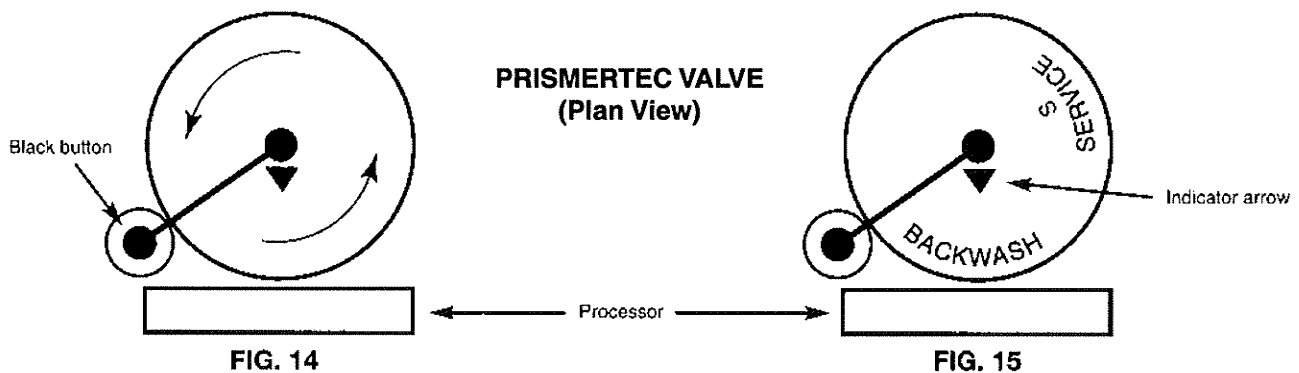

**ALWAYS** keep a minimum of 100mm (4") of salt in the water softener to ensure efficient regeneration and continuous softened water. A visual check should be carried out on a 3-6 weekly interval depending on usage. Refill as necessary.

**USE ONLY GRANULAR SALT:** we recommend Care Crystals.

**Note - adding water to the salt tank is not usually necessary. This is only necessary as part of the "Commissioning procedure".**

---

## 10 CONTROL PANEL SETTING

The control panel when first connected to the electrical supply will sequence between the "time of day" and "capacity"

### TO SET THE CORRECT TIME OF DAY

1. **NOTE - When the clock is correctly set regeneration will take place from 2.00am and last up to 132 minutes.**  
(The commencement time of 2.00am can be changed if desired, using the selector buttons as described below).

2. **NOTE - Before programming please ensure that the softener is still in the "S" service position.**

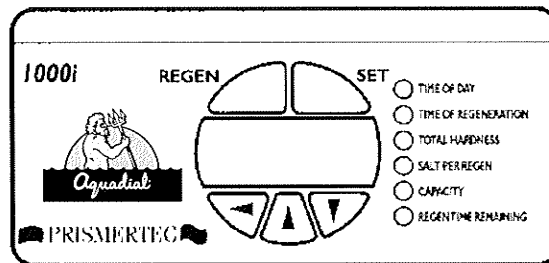

- i) Press ▼ until "Time of Day" indicator is illuminated, then press "SET" button. The right hand digit will flash on and off.
- ii) The time is displayed on a 24 hour clock basis.
- iii) Set the time of day by using the ▼ and ▲ buttons starting with the right hand digit. Once the correct number is reached press ◀ to select. Repeat the procedure on the next flashing digit.
- iv) Once the correct time has been established press the "SET" button after a few seconds the time of day/capacity will be displayed).

**NOTE - During normal service the control panel display will alternate between "Time of Day" and "Capacity".**

**\*capacity is the volume of softened water (shown in cubic metres) that the PrismaTEC can soften between the regenerations taking place.**

### To SET WATER HARDNESS

The degree of hardness found in water varies. The amount of hardness in water is directly linked to the amount of softened water available before regeneration is needed. It is therefore very important to check the amount of hardness in your local water supply and adjust your water softener if necessary. The PrismaTEC is factory set for water of 300ppm or mg/l hardness.

### TO CHANGE THE HARDNESS SETTING

- i) Press ▼ until "TOTAL HARDNESS" indicator is illuminated and then press "SET" button.
- ii) Using the ▲▼◀ buttons, select the hardness setting required using the same method used for setting the clock.  
(For use in the UK the extreme left and extreme right digits will be set at zero.)

### NORMAL/HIGH USAGE

The PrismaTEC is supplied factory set for normal usage (1-8 persons). If the high usage (1-10 persons) programme is required please contact Aqua-Dial for instructions on re-setting.

---

## 11 GUARANTEE (UK ONLY)

All Aqua-Dial automatic domestic water softeners are covered by a full one year parts and labour guarantee against faulty materials or workmanship.

Aqua-Dial have full service back-up covering the United Kingdom. For help, advice or service please phone the technical services department.

---

## 12 1 YEAR GUARANTEE (UK ONLY)

Aqua-Dial offer a "Peace of Mind" guarantee covering all parts, labour and call-out charges. In addition to this 12 month guarantee Culligan can offer you the option to extend this protection for a further period of two or four years.

Please complete and return the section on the reverse side of the guarantee card.

## HELP LINE

**If you require any help in using this manual or require further information please contact Aqua-Dial on 01376 334224. Thank you for choosing Aqua-Dial.**

## PARTS LIST - VALVE BODY

Ref No.	Part No	Description	Qty Req.
1	1034448	Valve body assembly	1
2	1034347	Motor Drive assembly	1
3	1034424	Control assembly	1
4	1034362	Can gear	1
5	1032881	Bracket	1
6	1005001	Screw	1
7	1033670	Turbine assembly	1
8	1000B14G2	Backwash control	1
9	1032988	Injector screw	1
10	150N150G25	Injector	1
11	1032985	Injector cap	1
12	1010140	'O'Ring	1
13	1010129	'O'Ring	1
14	1010429	'O'Ring	1
15	1009056	Cap plug, black 1/2"	1
16	1040717	Valve disk kit	1
17	1001580	Valve disk spring	11
18	1034360	Top plate assembly	1
19	1032416	Air Check	1
20	1032250	Drivegear	1
21	1006002	Screw	2
22	1031118	Spring	1
23	1006093	Top plate screw	17
24	1000N76G3	Valve cover	1
25	1001769	Adaptors 3/4" BSP thread	1 KIT
26	1000813	Transformer	1

### Valve Body

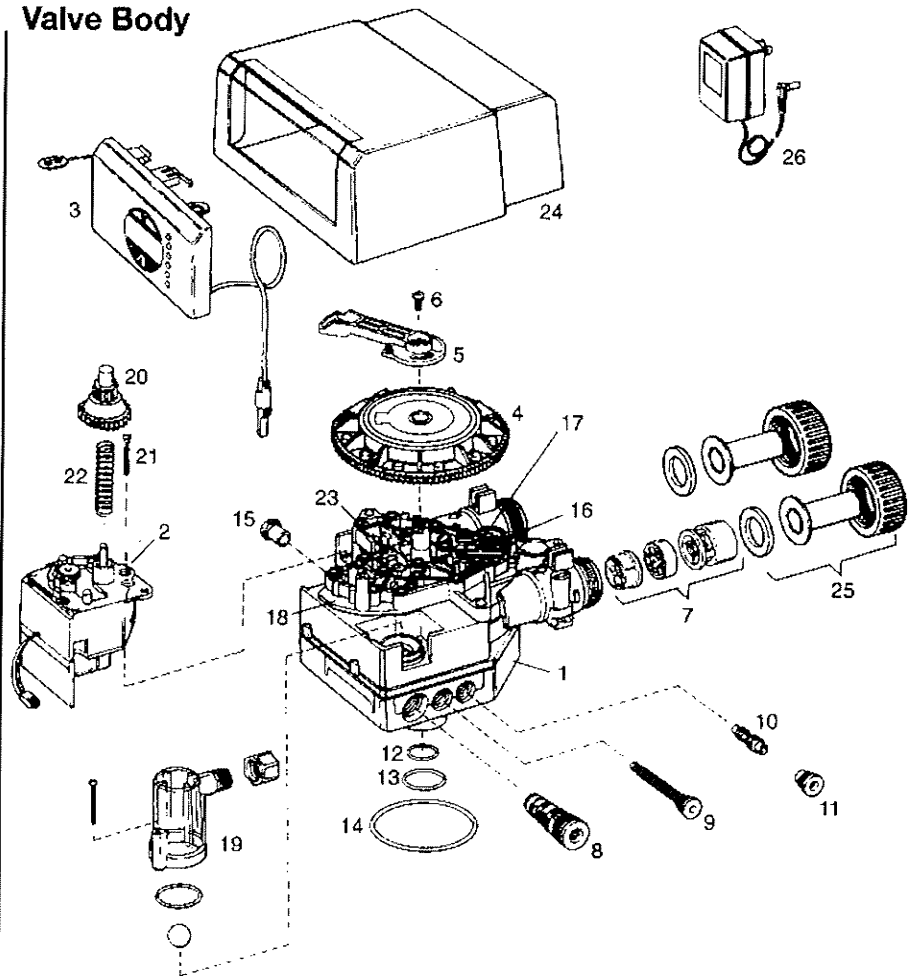

## TROUBLESHOOTING

Problem	Possible Cause	Solution
1. No illuminated display on processor.	No power to softener.	Check power outlet. Check power supply.
2. No soft water.	No salt in brine tank. By-pass valve open.	Add salt to brine tank and manually regenerate softener. Close by-pass valve.
3. Softener brine tank overflowing or overflowing.	→	Close inlet and outlet valves. Open by-pass valve - contact Aqua-Dial Service Department.
4. Other malfunction.	→	Contact Aqua-Dial Service Department.

**Culligan Number 1 in After Sales Service 01376 334224**



SPECIFICATION TABLE		
	Normal usage	High usage
Control	Microprocessor Meter Control with Total Proportional Salting	
Litres of Resin	11 Litres Dowex Monosphere	
Volume of Softened Water available per day at hardness of 300mg/l AS CaCO <sub>3</sub>	1360 Litres 300 Gallons	1700 Litres 375 Gallons
Salt used per regeneration (grams)	600	900
Max flow Litres per mm (#peak)	43 (70)	43 (70)
No of persons in household (people days based on 160 litres/person/day)	8	10
Size in mm (h x d x w) front facing	490mm x 477mm x 268mm	
Salt efficiency	79.5%	66.5%
<small>(#At 2 Bar Pressure loss.) Figures shown comply with the B.E.W.A. Quality Water Group Promotional guide lines and the B.E.W.A. C.O.P 01.85 Code of Practice for performance testing of salt regenerated ion exchange water softeners.</small>		

**NOTES**

1. To introduce an additional or manual regeneration press the Regen button until an audible click is heard. The Prismertec will take approximately 132 minutes to complete a full cycle during which time no softened water is available to replace any water used in the plumbing system.
2. For minimum and maximum salt levels see Fig. 13, page 5
3. Regeneration normally takes place at 2am and lasts up to 132 minutes. Regeneration frequency is controlled by the Prismertec's integral microprocessor system.

**SALT**

Salt is essential to make the water softener work. It is dissolved in water to make a concentrated brine solution, which is washed over the resin to recharge it. The salt never enters the household water.

You should use only granular salt specially made for water softeners\*. Product quality does vary from one manufacturer to another, with some products containing damaging impurities or being liable to fall apart (mush). That is why we recommend Care Crystals which is made to the highest quality standards.

Care Crystals salt comes in 25kg and 10kg bags and is usually available from the company that supplied your water softener. If you need any assistance in finding your local supplier, please call 01376 334200.

**ALWAYS** keep a minimum of 100mm (4") of salt in the water softener to ensure efficient regeneration and continuous softened water. A visual check should be carried out on a 3-6 weekly interval depending on usage. refill as necessary.

**\* Do not use block or tablet salt. Use of block or tablet salt will result in improper regeneration. Use only granular salt.**

Softened water has a higher sodium content than mains water and the Department of Health currently recommend that it should not be used for drinking and cooking. In fact the level of sodium in softened water is typically less than one quarter of that in milk. After installation of your water softener you will still have an unsoftened mains tap. It is particularly important that unsoftened water is used for mixing powdered milk for babies as the powdered milk will already contain the correct level of sodium.



Culligan International (UK) Limited  
 Culligan House  
 The Gateway Centre  
 Coronation Road  
 Hugh Wycombe  
 Buckinghamshire HP12 3SU

*As part of the Culligan policy of continuous improvement all specifications are subject to change without prior notice.*

**PLEASE RETAIN THIS MANUAL**

Date Installed .....

Purchased From .....

.....  
 .....

Guarantee Registered / /

For any installation, programming or technical assistance please contact Culligan service on:  
 Tel: 01376 334224  
 Fax: 01376 334201